

1. Cut wood to specifications in Figure 5.
  - a. Sand any openings with rough edges (vents and chamber throughpoints)
2. Mark boards with a pencil
  - a. Post:
    - i. Sketch the location of all post spacer locations
    - ii. Draw a line on all four sides of the post 48" from the top
    - iii. Begin scuffing the post from its top to the line drawn in the previous step, being careful not to scuff the future spacer locations (we use a 1" hole saw for this process)
  - b. Inner sleeve (Figure 1):
    - i. Mark the top of the four inner sleeve boards with a letter (A–D)
    - ii. Draw a line from the top of each board to the bottom that is  $\frac{3}{4}$ " from the edge nearest you (indicated by the blue line in Figure 1)  
*\* from this point on, blue lines indicate draw lines\**
    - iii. Make the following marks on the line drawn in Step 2.a.ii.: 1" from the top, followed by marks every 8" thereafter
    - iv. Midway between the edge of the board and the  $\frac{3}{4}$ " line drawn in Step 2.a.ii. draw an "x" to indicate the location for drilling (the center of this "x" should be  $\sim\frac{3}{8}$ " from the edge of the board)
    - v. Mark and label the location for each inner sleeve spacer as indicated by the gray blocks in Figures 1 & 6.
    - vi. The dotted spacer lines represent an *approximate* location of the post spacers after the inner sleeve has been put together. In addition, the \* represent *approximate* pre-drill locations. You will drill these points in a later step (step 9).

**Figure 1:**

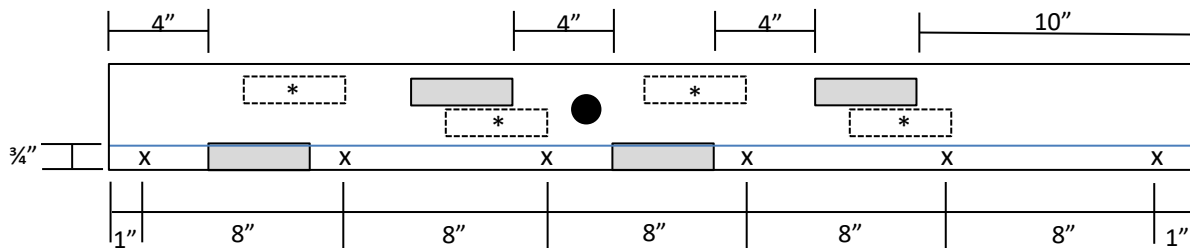

- c. Outer sleeve:
  - i. Mark the top of the four outer sleeve boards with the letters (AA, BB, CC, and DD)
  - ii. Draw a line from the top of each board to the bottom that is  $\frac{3}{4}$ " from the edge nearest you
  - iii. Make the following marks on the line drawn in Step 2.b.ii.: 1" from the top, followed by marks every 8" thereafter

- iv. At each of the marks made in the previous step, midway between the edge of the board and the  $\frac{3}{4}$ " line drawn in Step 2.b.ii., draw an "x" to indicate the location for drilling (the center of this "x" should be  $\sim\frac{3}{8}$ " from the edge of the board)
- v. The dotted spacer lines represent an *approximate* location of the internal sleeve spacers after the outer sleeve has been put together. In addition, the \* represent *approximate* pre-drill locations. You will drill these points in a later step (step 11).

**Figure 2:**

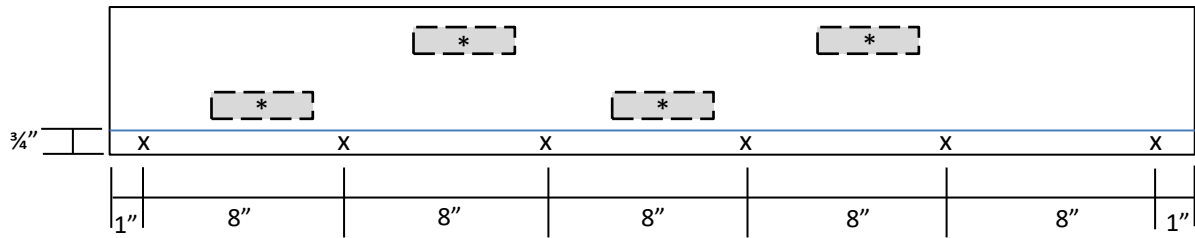

- d. Spacers:
  - i. Mark each spacer along the midpoint, 1" from an edge as indicated in Figure 3 (only make one "x" mark as the second mark will be added in the future)

**Figure 3:**

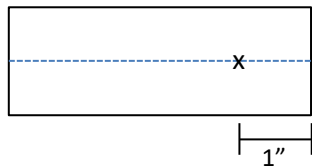

- e. Roof Units:
  - i. Mark the boards on all sides  $\frac{3}{4}$ " from the edge as indicated in Figure 4

**Figure 4:**

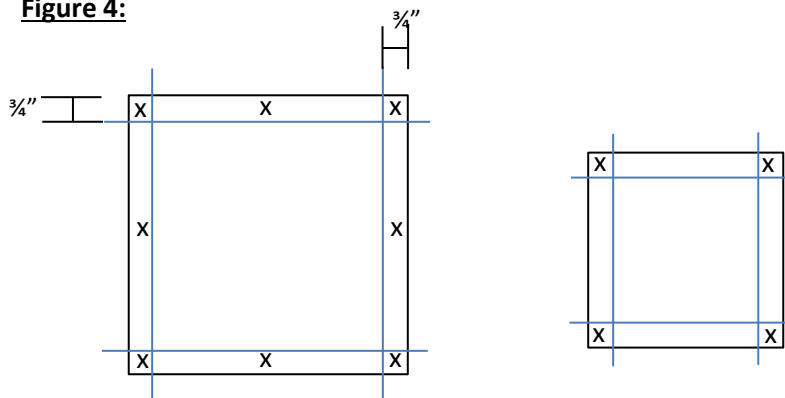

3. Drill countersink holes in the previously marked locations
  - a. Widen the countersink holes with a 1/8" drill bit
4. Scuff the inner sleeve boards from top to bottom on their "outer" layer
5. Begin inner and outer sleeve assembly
  - a. Inner sleeve and outer sleeve Assembly:
    - i. Assemble the inner sleeve with 1-5/8" screws as indicated in Figure 6, making sure that the edges of one board are flush with the other. I recommend starting at one end and adding each screw individually. This method enables you to manually adjust the board as needed. Caulk should be used to seal any gaps from this point on.  
*\*DO NOT forget to pre-drill to prevent cracks!\**
    - b. Attach the smaller roof to the inner sleeve and the larger roof to the outer sleeve using 1-5/8" deck screws. Attempt to keep the edge of the roof and the shell flush. This is easier if you screw in opposite corners first.
6. Attach spacers to the post with 1-1/4" deck screws. At this point the second hole can be drilled into each spacer.
7. Attach the spacers to the inner sleeve with 1-1/4" deck screws. At this point the second hole can be drilled into each spacer, but be mindful of the inner sleeve edge screws.
8. Slide the inner sleeve over the post, making sure that the top of the post touches the roof of the inner sleeve.
9. Drill the countersink and 1/8" holes through the inner sleeve and into each of the post spacers. The holes should be drilled in the center of each post spacer to prevent interference with other screws.  
*\*This step will require you to observe the location of each spacer within as their precise locations may vary from the figures\**
  - a. Use 2" screws to attach the inner sleeve to the post spacers via these freshly drilled holes
10. Slide the outer sleeve over the inner sleeve and post, making sure that the inner sleeve and outer sleeve roofs are touching
11. Drill the countersink and 1/8" holes through the outer sleeve and into each of the inner sleeve spacers. The holes should be drilled in the center of each spacer to prevent interference with other screws.  
*\*This step will require you to observe the location of each spacer within as their precise locations may vary from the figures\**
  - a. Use 2" screws to attach the outer sleeve to the inner sleeve spacers via these freshly drilled holes

Comments:

Painting can be done at any point after outer sleeve boards have been cut and drilled. Nontoxic paint and primer should be used.

If you have any questions, comments, or concerns contact Frank Tillman at [ftillman1@sycamores.indstate.edu](mailto:ftillman1@sycamores.indstate.edu) or [frankietillman@gmail.com](mailto:frankietillman@gmail.com)

**Figure 5:**

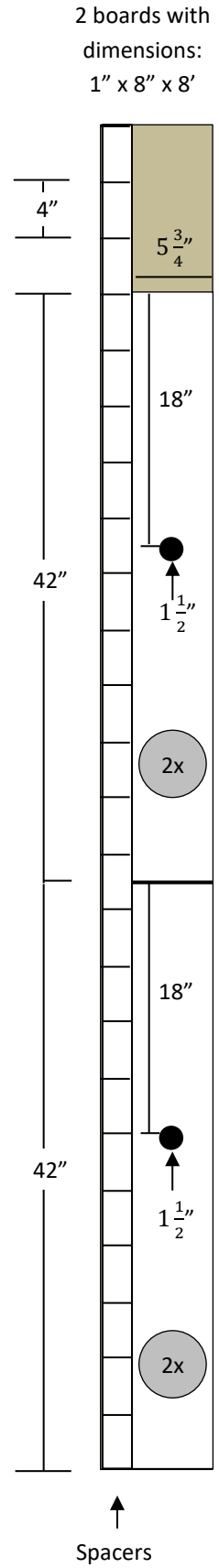
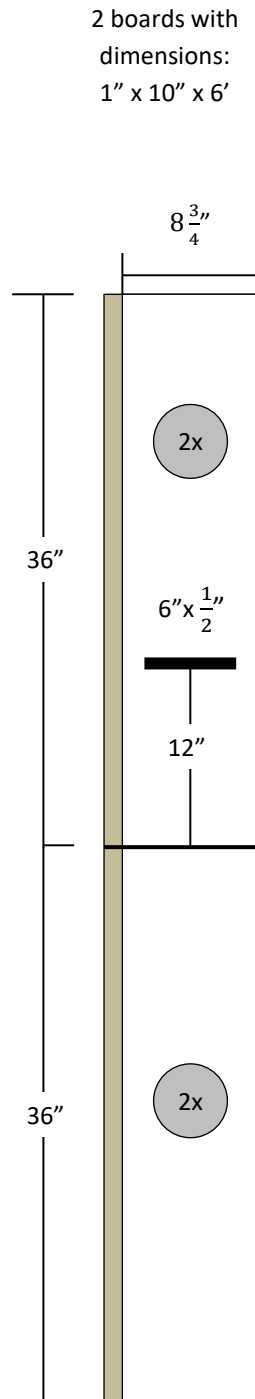
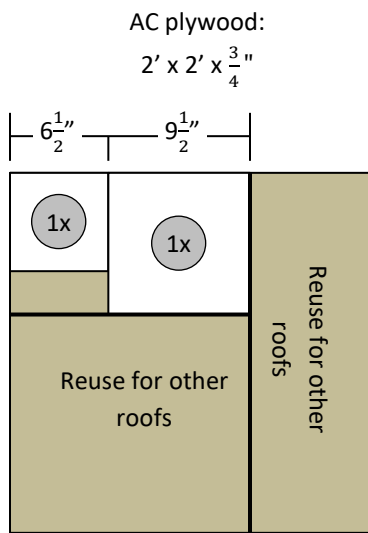

**Figure 6:**

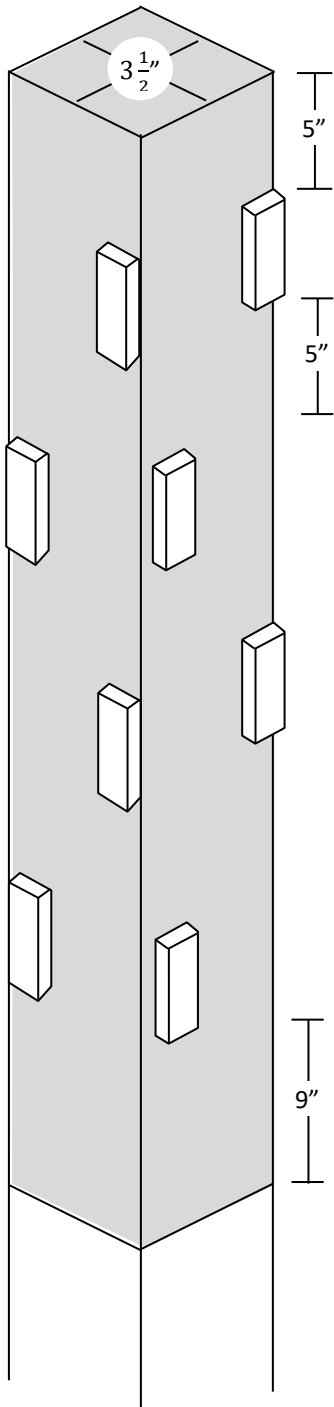

**Post with spacers**

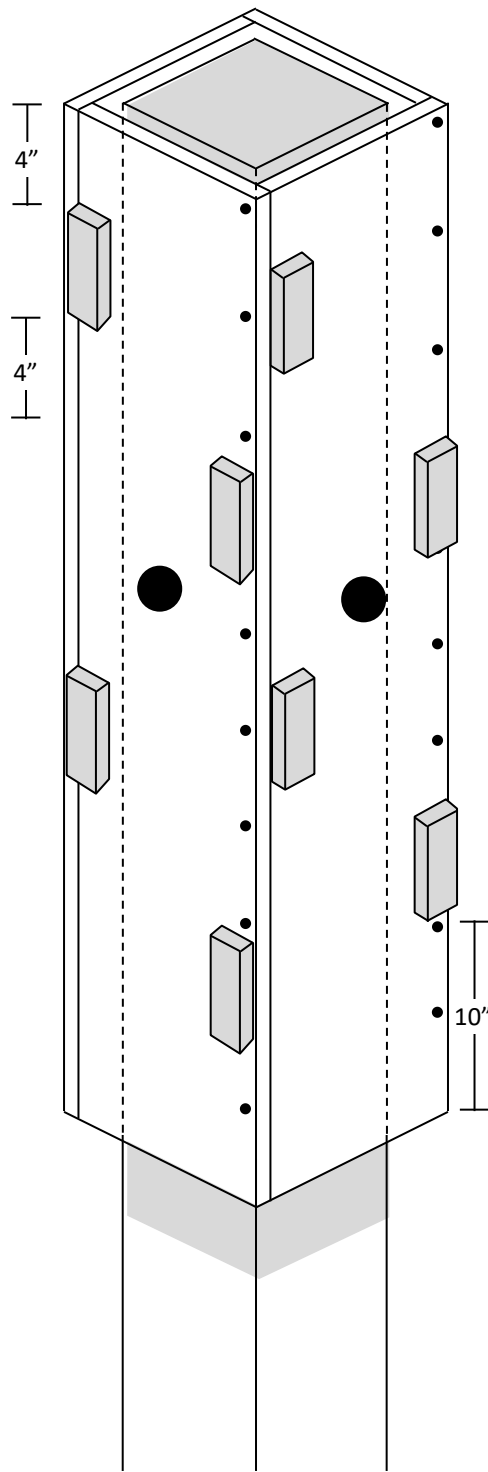

**Inner shell**

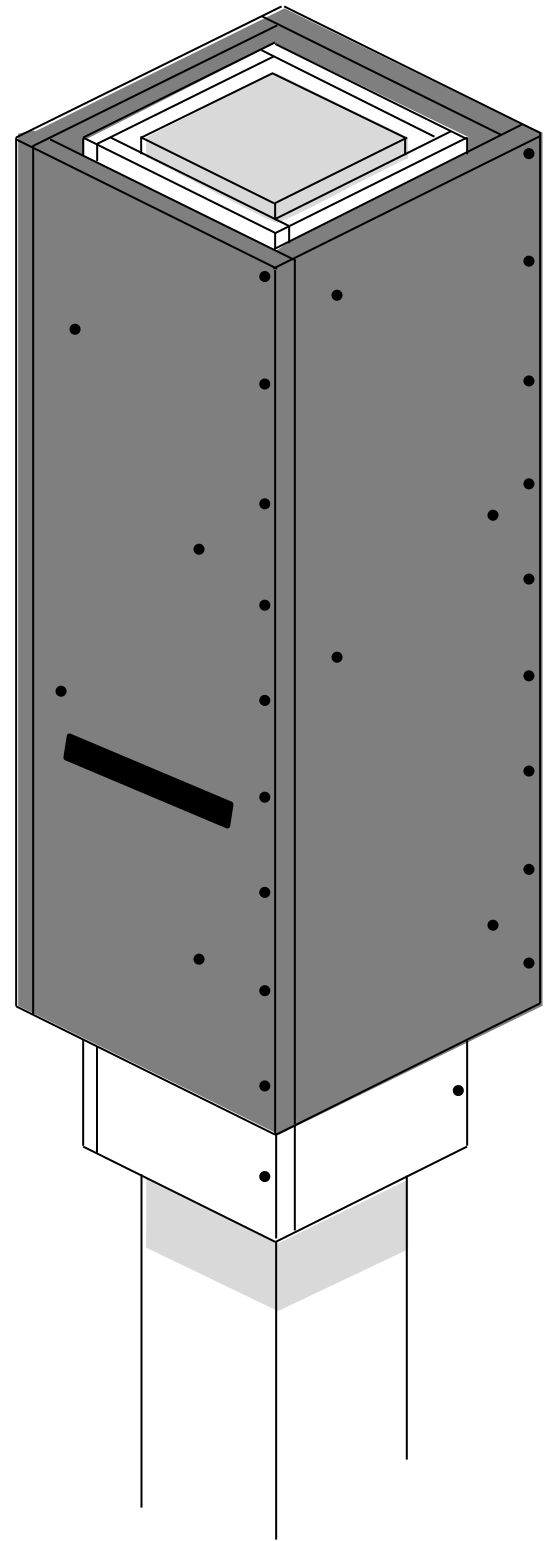

**Completed bat box  
(without roof)**